

Design & Technology

F2 Cup Mat

2122

L7-P.1 Zoom

A) Devices

- ❑ PC/Notebook/ Tablet 平板電腦 - Mac Book, I pad

B) Devices

- ❑ Smart Phone

1) Lkt Gmail

- ❑ Id number/ Password

2) Google Classroom

- ❑ L 7

3) Google Slide

- ❑ Google Drive – 2A01dt

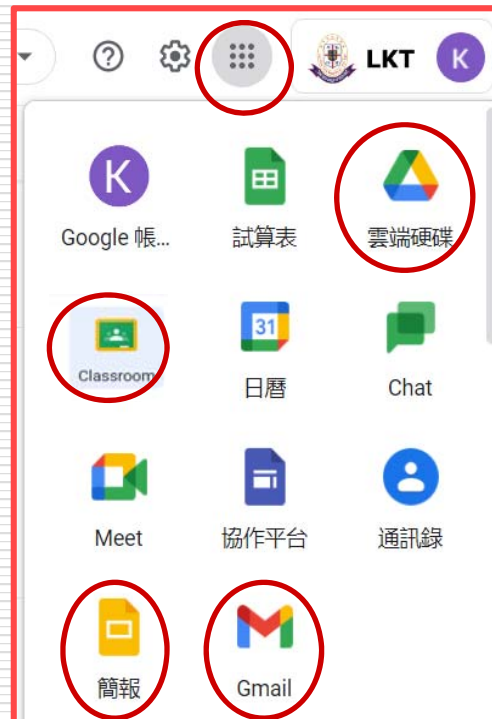

C) Prepare

- ❑ Graph Paper
- ❑ Pencil
- ❑ Eraser
- ❑ Ruler

Design & Technology

F2 Cup Mat

2122

L7-P.2 Zoom

Learning Tasks :

Google Slide

- Finished P.10,11,12

Free Hand Sketch

- Finish your design
- insert photos in P.11

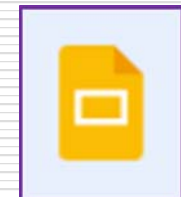

Design & Technology

F2 Cup Mat

2122

L7-P.3 Zoom

Materials Provided

2022 02 12 (AM)

2A Rm301	2B Rm302	2C Rm101
2D Rm204	2E Rm205	

4 types of Materials

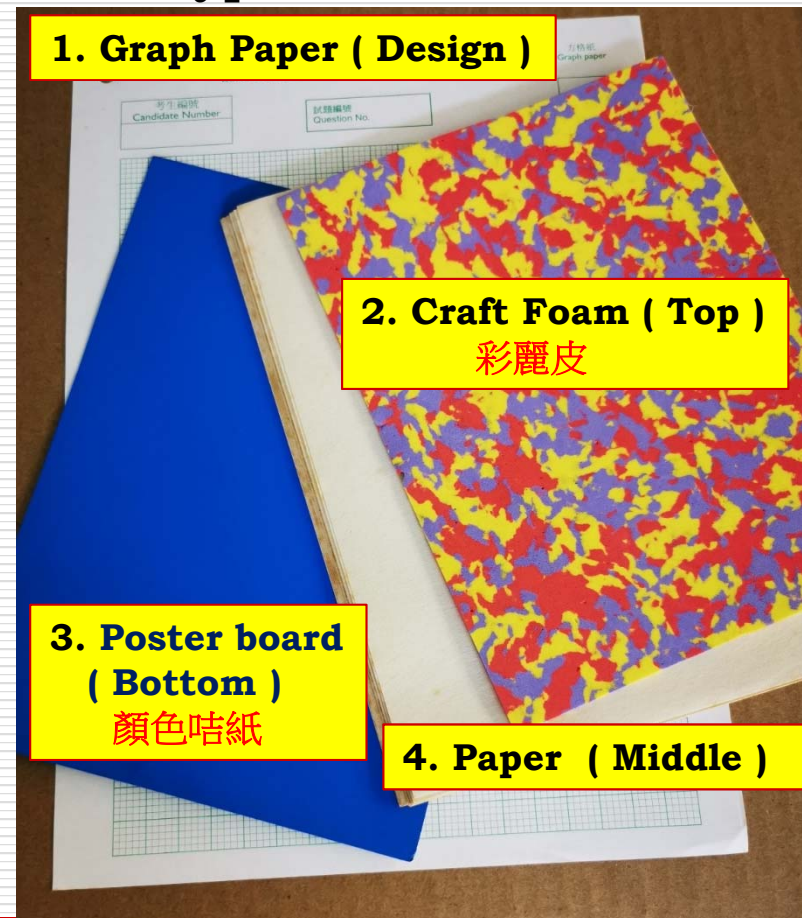

Design & Technology

F2 Cup Mat

2122

L7-P.4 Zoom

Extra Materials on Other Day

Pigeonhole



Materials - CM Purchase List CBS

1) A 4 繪圖工程網格紙 一張 (CBS)



淘寶 | 中國
Taobao | 香港

情侶裝秋裝外套 搜索

半身裙 保暖襯衫 真皮女包單肩包 書包男 地毯 電動車 短靴 套裝襪秋 春秋外套女修身 更多...

首頁 > 文具電教/文化用品/商務用品 > 更多畫具/書法用品 > 繪圖/白圖紙

加厚座標紙A0網格紙A3學生繪圖建築設計16K8K4K米格a2畫圖手繪製圖a1網格紙a4紅色格子二號圖紙K...

銷量 200+ | 評價 2000+

¥8.80 ¥9.00

約HKD 10.81-20.64

物流 香港地區直郵預計5~8天到達
下單頁多種物流方式可供選擇

支付 AlipayHK Credit/Debit card VISA 支持港幣支付

多規格可選
包郵 坐标纸网格纸

查看詳情並購買 分享

網址: <https://world.taobao.com/item/27142292922.htm?spm=a21wu.10013406-tw.taglist-content.1.4a463887Mv9rL9>

1. Graph Paper (Design)

2. Craft Foam (Top) 彩麗皮

3. Poster board (Bottom)
顏色咭紙

4. Paper (Middle)

5. Glue Stick 漿糊筆

6. Cutter 美工刀

7. 5 Marker 顏色麥克筆5枝

8. White Glue 白膠漿

Materials - CM Purchase List HKS

1) A4 繪圖工程網格紙 一張 (CBS)

淘寶 中國 香港 Taobao

情侶裝秋裝外套 搜索

半身裙 保暖襯衫 真皮女包單肩包 書包男 地毯 電動車 短靴 套裝襪秋 春秋外套女修身 更多...

首頁 > 文具電教/文化用品/商務用品 > 更多畫具/書法用品 > 繪圖/白圖紙

加厚座標紙A0網格紙A3學生繪圖建築設計16K8K4K米格a2畫圖手繪製圖a1網格紙a4紅色格子二號圖紙K...

銷量 200+ | 評價 2000+

¥8.80 ¥9.00
約HKD 10.81-20.64

物流 香港地區直郵預計5~8天到達
下單頁多種物流方式可供選擇

支付 AlipayHK Credit/Debit card VISA 支持港幣支付

多規格可選 包郵 坐标纸网格纸

查看詳情並購買 分享

網址: <https://world.taobao.com/item/27142292922.htm?spm=a21wu.10013406-tw.taglist-content.1.4a463887Mv9rL9>

1. Graph Paper (Design)

2. Craft Foam (Top) 彩麗皮

3. Poster board 顏色咭紙

4. Paper (Middle)

5. Glue Stick 漿糊筆

6. Cutter 美工刀

7. 5 Marker 顏色麥克筆5枝

8. White Glue 白膠漿

Materials – Prepare for the Next Meeting

1) A 4 繪圖工程網格紙 一張 (CBS)

淘寶 | 中國
Taobao | 香港

情侶裝秋裝外套 搜索

半身裙 保暖襯衫 真皮女包單肩包 書包男 地毯 電動車 短靴 套裝襪秋 春秋外套女修身 更多

首頁 > 文具電教 / 文化用品 / 商務用品 > 更多畫具 / 書法用品 > 繪圖 / 白圖紙

加厚座標紙A0網格紙A3學生繪圖建築設計16K8K4K米格a2畫圖手繪製圖a1網格紙a4紅色格子二號圖紙K...

銷量 200+ | 評價 2000+

¥8.80 ¥9.00
約HKD 10.81-20.64

物流 香港地區直郵預計5~8天到達
下單頁多種物流方式可供選擇

支付 AlipayHK Credit/Debit card VISA 支持港幣支付

多規格可選
包郵 坐标紙網格紙

查看詳情並購買 分享

網址：<https://world.taobao.com/item/27142292922.htm?spm=a21wu.10013406-tw.taglist-content.1.4a463887Mv9rL9>

1. Graph Paper (Design)

2. Craft Foam (Top) 彩麗皮

3. Poster board 顏色咭紙

4. Paper (Middle)

5. Glue Stick 漿糊筆

6. Cutter 美工刀

7. 5 Marker 顏色麥克筆5枝

8. White Glue 白膠漿

Design & Technology

F2 Cup Mat

2122

L7-P.8 Zoom

Construction of Three Layers Cup Mat

Middle - Thickness
Foam Board
Paper 廢紙

Base - Simple Design
Wood
Poster board 顏色咭紙

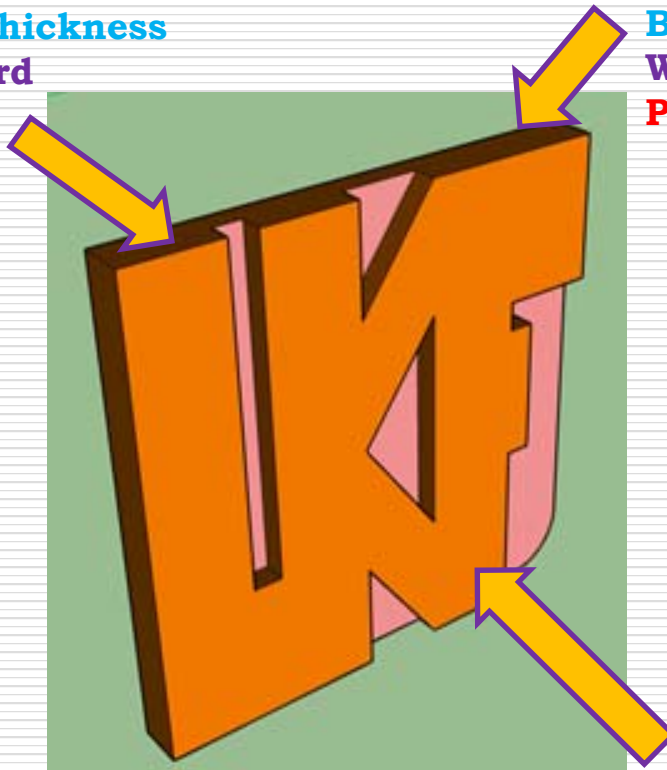

Top - Water Proof
Corrugated Plastic Board
瓦通膠板
Craft foam 彩麗皮

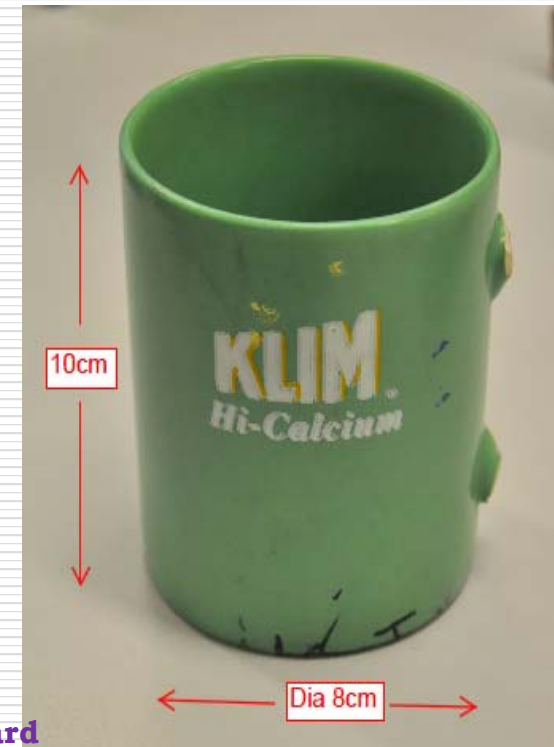

Design & Technology

2122

F2 Cup Mat

L7-P.10 Zoom

Tools and Materials- Cup Mat

Example of P.12

1	2
5	6
9	10
13	14



1.Insert

2.Table (4x4)

插入 設計 轉場 動畫

新增投影片
投影片
95

表格 圖片

4x4 表格

插入表格(I)...

手繪表格(D)

Excel 試算表(X)

Design & Technology

2122

F2 Cup Mat

L7-P.11 Zoom

Tools & Material – Cup Mat (Example of P.12)

1. Graph Paper 	2. Craft Foam 	3. Poster board 	4. Paper 
5. Pencil 	6. Ruler 	7. Eraser 	8.
9.	10.	11.	12.
13.	1) Insert 7 photos with name from a) T:\19 Dt 設計與工藝\KFLeung\F2\Pptx info\ Tools Material & Supplies b) Google Classroom		

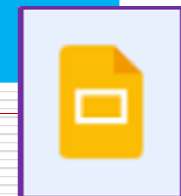

Cup Mat Design – Sketch Up **Example of P.11**

Graph Paper

Sketch Up

Graph Paper

Sketch Up

- 1. Insert table with 4 cells**
- 2. Insert titles in cells**

Data Collection – Cup Mat Example of P.10

1	2
5	6



1.Insert

2.Table(4x2)

4x2 表格



Design & Technology

2122

F2 Cup Mat

L7-P.14 Zoom

Data Collection – Cup Mat (Example of P.10)

1. Insert a table with 8 cells

2. Numbering

1



Simple and neat design

2



3



4



5



6



7



8



4. Circle your Choice with reason

3. 8 ideas from web (crop)



Design & Technology

F2 Cup Mat

2122

L7-P.15 Zoom

Develop your idea
by
Graph Paper

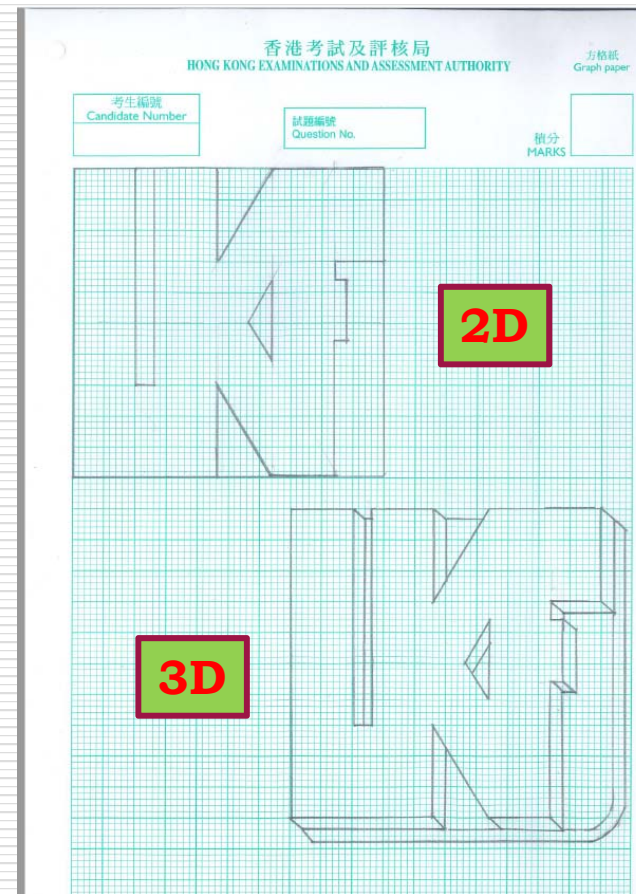

WORKSHOP PRACTICE
An Introduction



Design & Technology

2122

F2 Cup Mat

L7-P.16 Zoom

Step 1 :
Draft your idea with
pencil and ruler

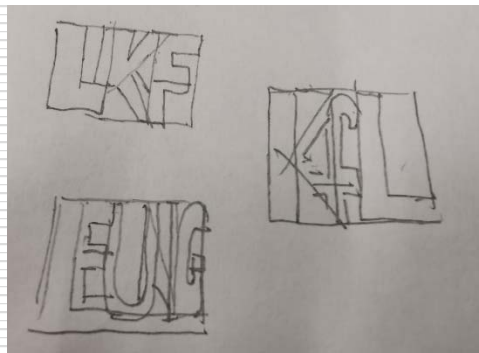

Step 2 :
Transfer your idea on graph paper 100x100mm

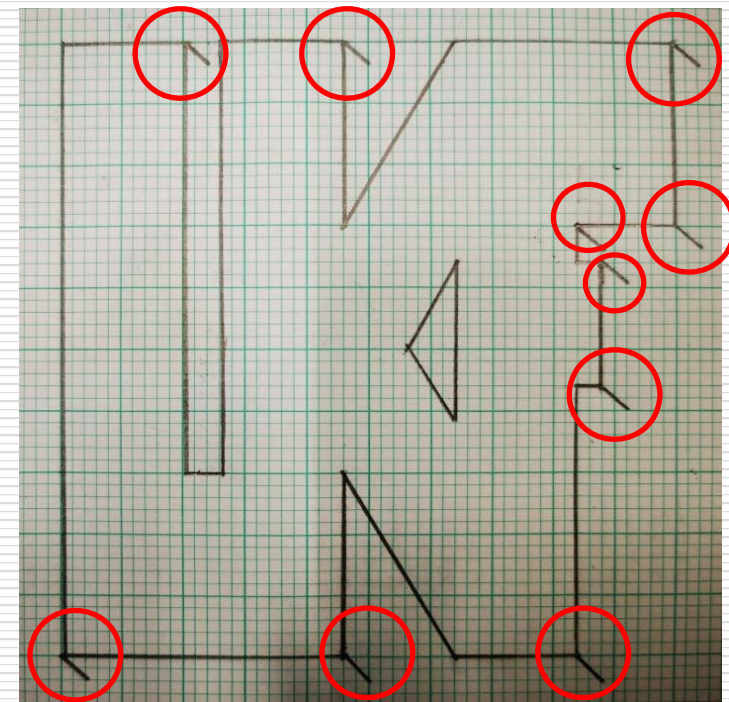
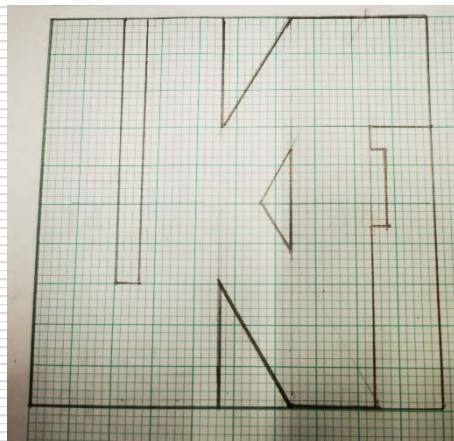

Step 3 :
Mark a 45° lines at each corner



Design & Technology

F2 Cup Mat

2122

L7-P.17 Zoom

Step 4 :
Join the 45 lines to form 3D shape

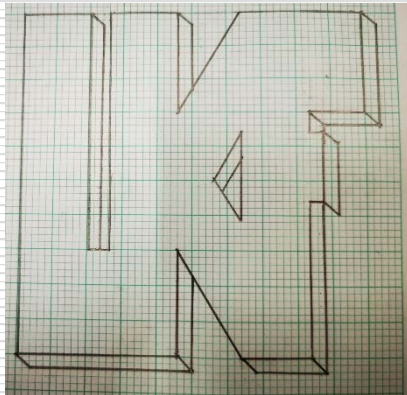

Step 5 :
Track the top of the base

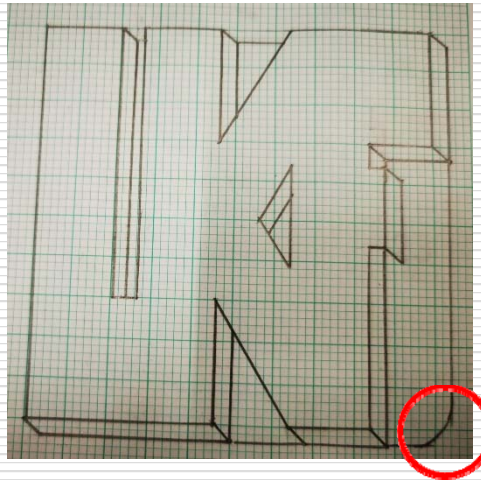

Step 6 :
Draw 3D shape of the base

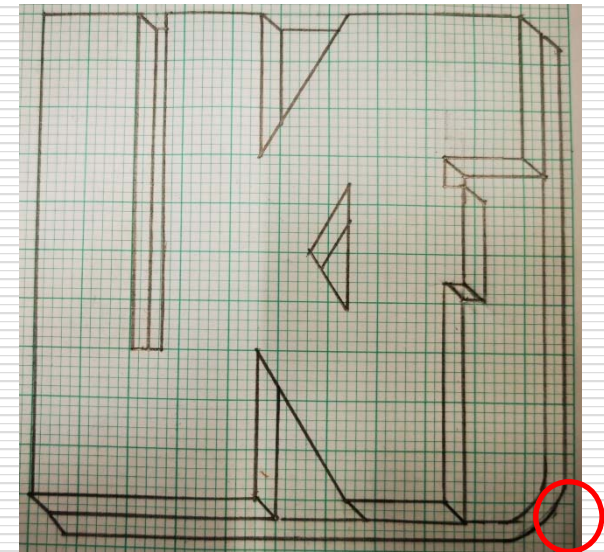

WORKSHOP PRACTICE
An Introduction



Cup Mat Design – Sketch Up **Example of P.11**

Graph Paper
(2D)

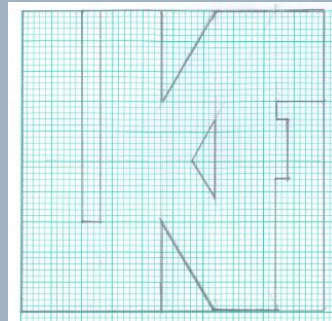

Sketch Up

Graph Paper
(3D)

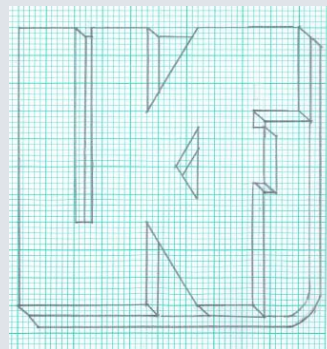

Sketch Up

Conclusion:

1. Google Slide

- insert words & photos**
- insert print screen image**

2. Free Hand Sketching

- design work on Cup Mat**
- insert photos in google slide**

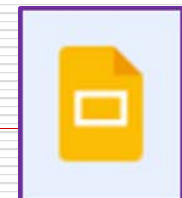

Learning Tasks :

Google Slide

- Finished P.12,14
- Prepare for P.11

SketchUp for School/Free Hand Sketch

- Finish your design
- insert two print screen in P.11

Making of Cup Mat

- Sticking of Paper
- Sticking of Graph Paper 2D with Craft Foam
- Sticking of Graph Paper 3D with Poster Board

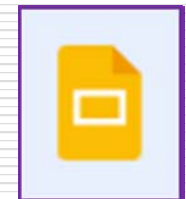

Materials – Prepare for the Next Meeting

1) A 4 繪圖工程網格紙 一張 (CBS)

淘寶 | 中國
Taobao | 香港

情侶裝秋裝外套 搜索

半身裙 保暖襯衫 真皮女包單肩包 書包男 地毯 電動車 短靴 套裝襪秋 春秋外套女修身 更多...

首頁 > 文具電教/文化用品/商務用品 > 更多畫具/書法用品 > 繪圖/白圖紙

加厚座標紙A0網格紙A3學生繪圖建築設計16K8K4K米格a2畫圖手繪製圖a1網格紙a4紅色格子二號圖紙K...

銷量 200+ | 評價 2000+

¥8.80 ¥9.00
約HKD 10.81-20.64

物流 香港地區直郵預計5~8天到達
下單頁多種物流方式可供選擇

支付 AlipayHK Credit/Debit card VISA 支持港幣支付

多規格可選
包郵 坐标纸网格纸

查看詳情並購買 分享

網址：<https://world.taobao.com/item/27142292922.htm?spm=a21wu.10013406-tw.taglist-content.1.4a463887Mv9rL9>

1. Graph Paper (Design)

2. Craft Foam (Top) 彩麗皮

3. Poster board 顏色咭紙

4. Paper (Middle)

5. Glue Stick 漿糊筆

6. Cutter 美工刀

7. 5 Marker 顏色麥克筆5枝

8. White Glue 白膠漿

Design & Technology

2122

F2 Cup Mat

L8-P.5 Zoom

Tools & Material – Cup Mat (Example of P.12)

1.	2.	3.	4.
1) Insert 4 photos with Name from a) T:\19 Dt 設計與工藝\KFLeung\F2\Pptx info\ Tools Material & Supplies b) Google Classroom			8 Glue Stick 
9. 	10. 	11. 	12.
13.	14.	15.	16.

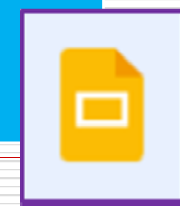

Design & Technology

2122

F2 Cup Mat

L8-P.6 Zoom

Making – Cup Mat (Example of P.14)

1. Graph Paper Design	2. Sticking with Glue Stick	3. Cutting
4. Coloring	5. Sticking with White Glue	6. Final Product

Insert 6 cells with sub titles

Design & Technology

F2 Cup Mat

2122

L8-P.7 Zoom

Open

I:\Homework\Dt\F2\2A01dt.skp

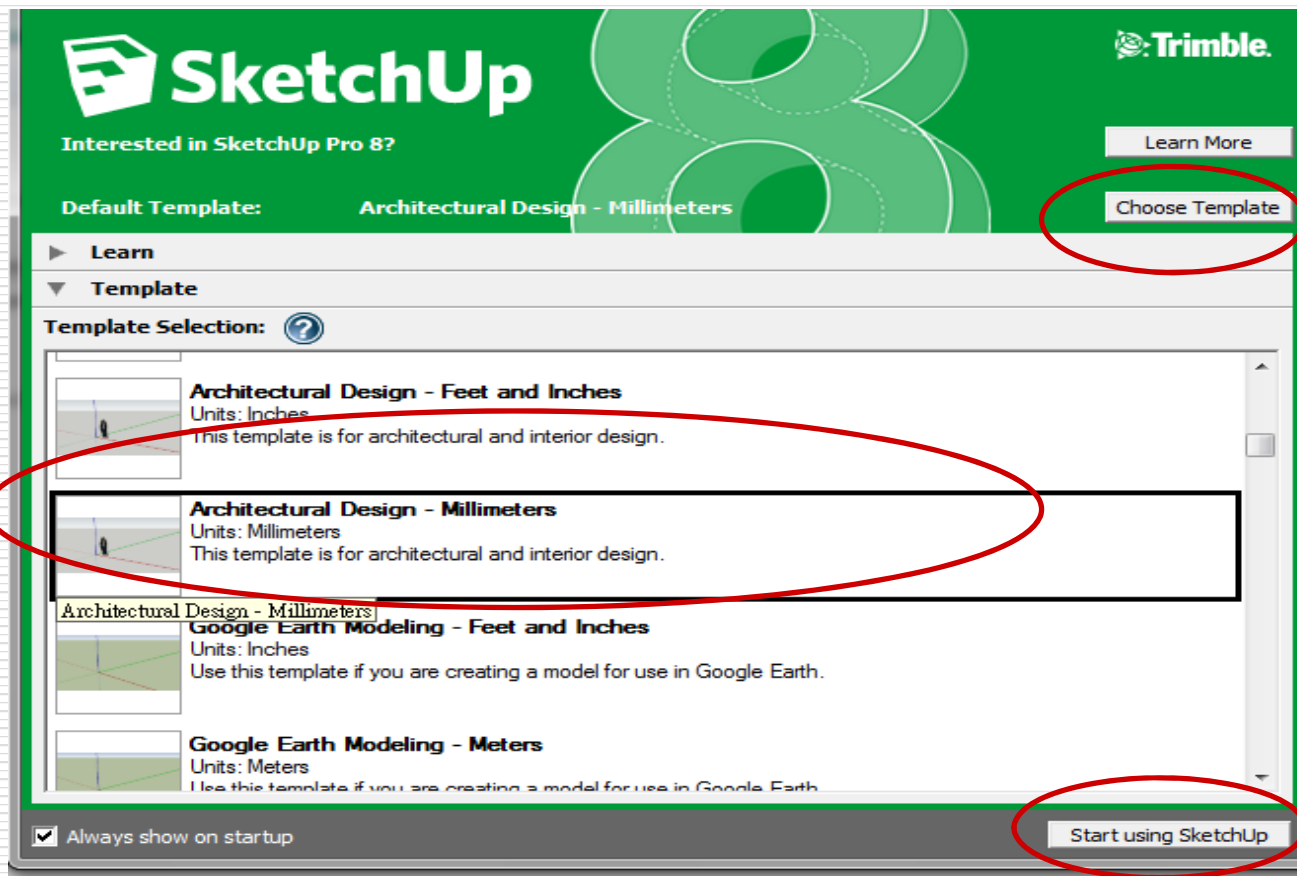
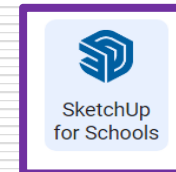

CHOSE TEMPLATE

MILLIMETERS

START USING SKETCHUP

Design & Technology

F2 Cup Mat

2122

L8-P.8 Zoom

Open I:\Homework\Dt\F2\2A01dt.skp

Delete the Practice Exercises

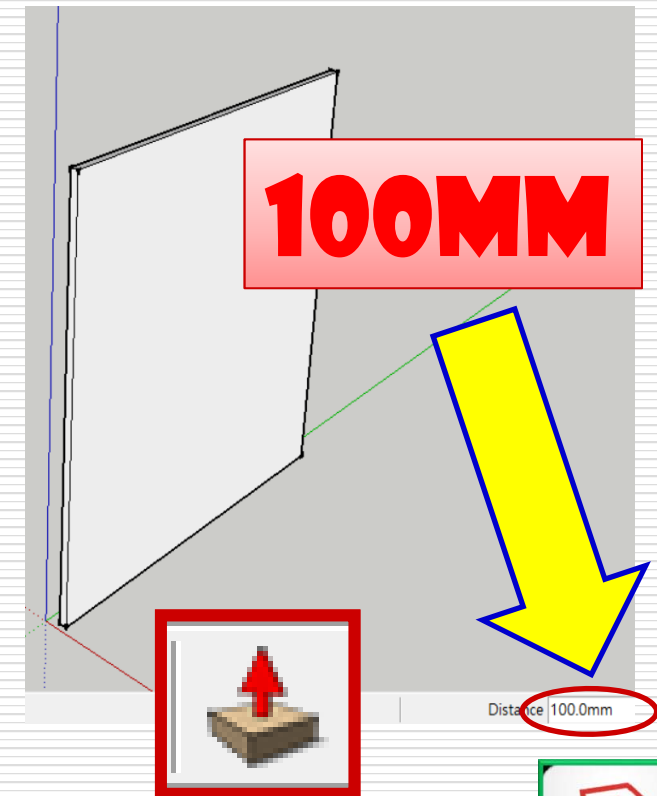
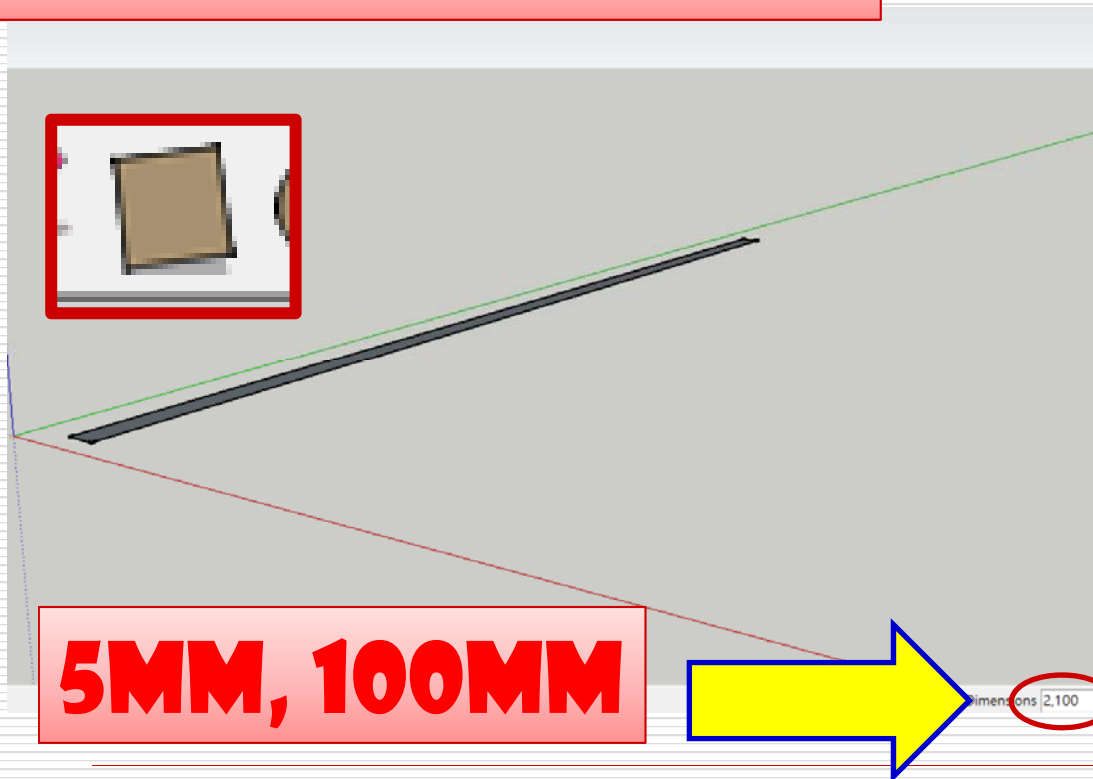

Sketch Up Web Setting

The screenshot shows the SketchUp Web settings page. The browser tab is titled "無標題" (Untitled), which is circled in red. The left sidebar contains navigation options: 首頁 (Home), 新增 (New), 開啟 (Open), 另存為 (Save As), 匯入 (Import), 匯出 (Export), 下載 (Download), 應用程式設定 (Application Settings), and 新增位置 (Add Location). The "應用程式設定" option is circled in red. The main content area is titled "設定" (Settings) and is divided into sections: "一般" (General), "可存取性" (Accessibility), and "導覽" (Navigation). Under "一般", the "自動儲存" (Auto Save) section is active, showing a toggle switch turned on and a "儲存間隔分鐘數" (Save Interval in Minutes) input field set to 5. The "地區" (Region) section shows "語言" (Language) set to "繁體中文" (Traditional Chinese) and "預設範本" (Default Template) set to "Decimal - Millimeters", both of which are circled in red.



Design & Technology

F2 Cup Mat

2122

L8-P.10 Zoom

Save your work in Google Drive

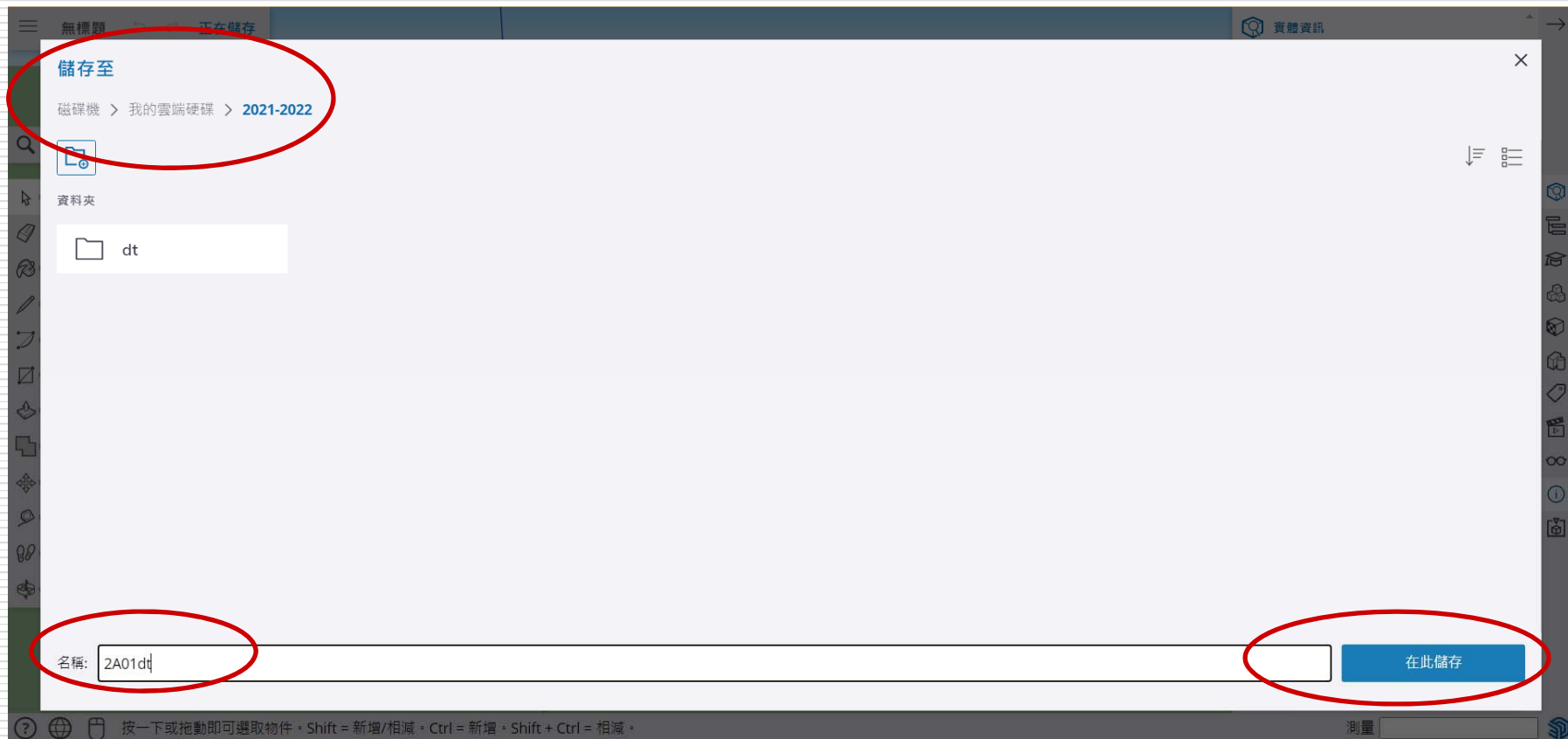

Design & Technology

F2 Cup Mat

2122

L8-P.11 Zoom

Draw with rectangle  5,100 and push up  100

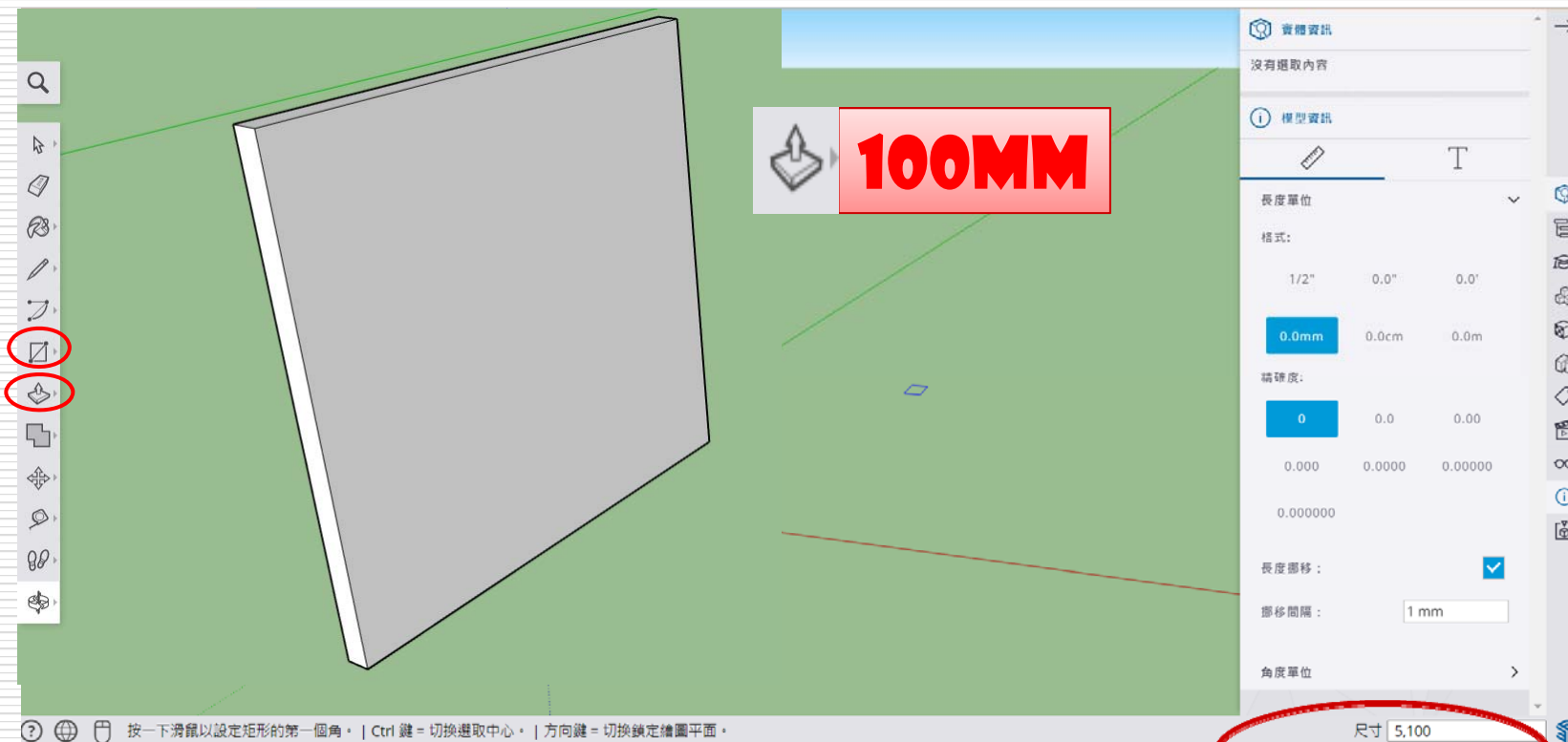

 5MM, 100MM

Design & Technology

F2 Cup Mat

2122

L8-P.12 Zoom

Draw your design with different tools

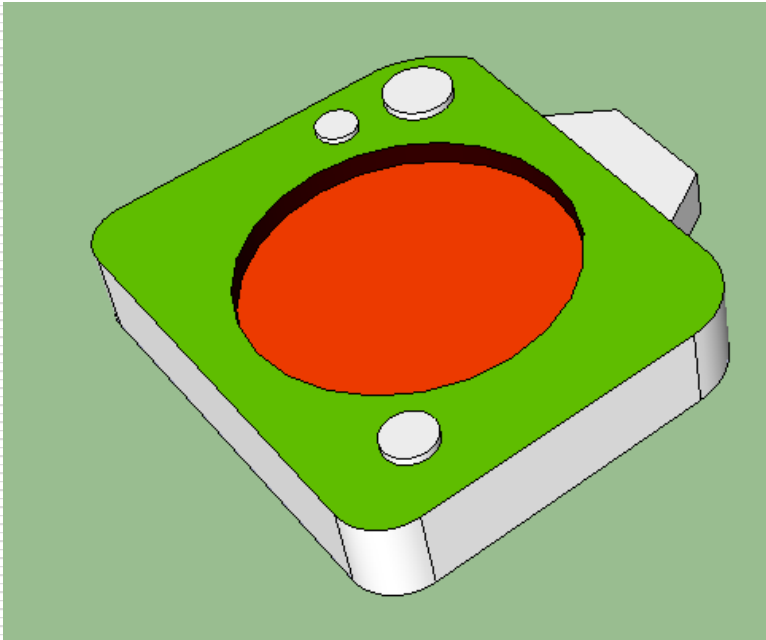

Concave Design

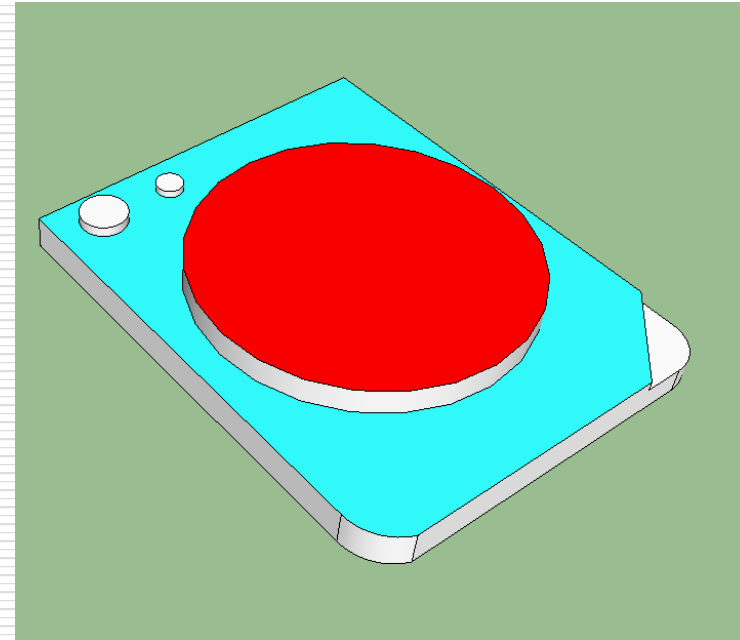

Convex Design

Cup Mat Design – Sketch Up Example of P.11

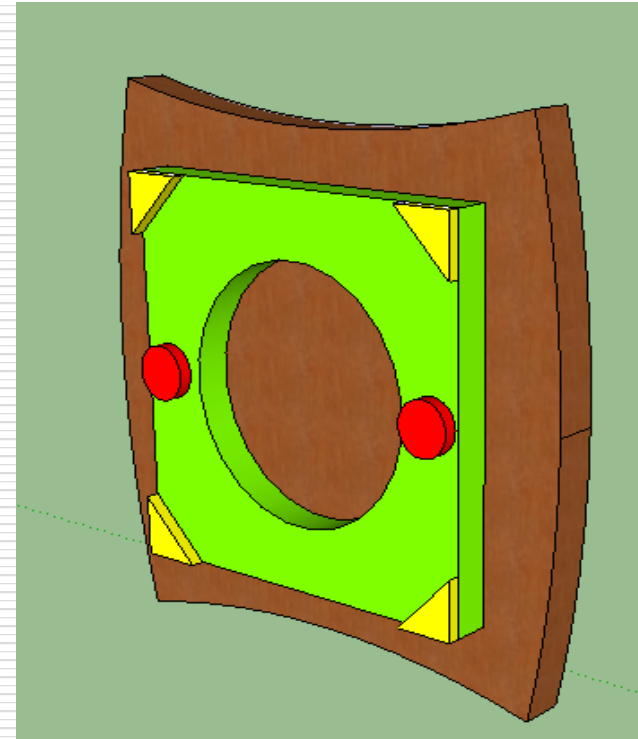
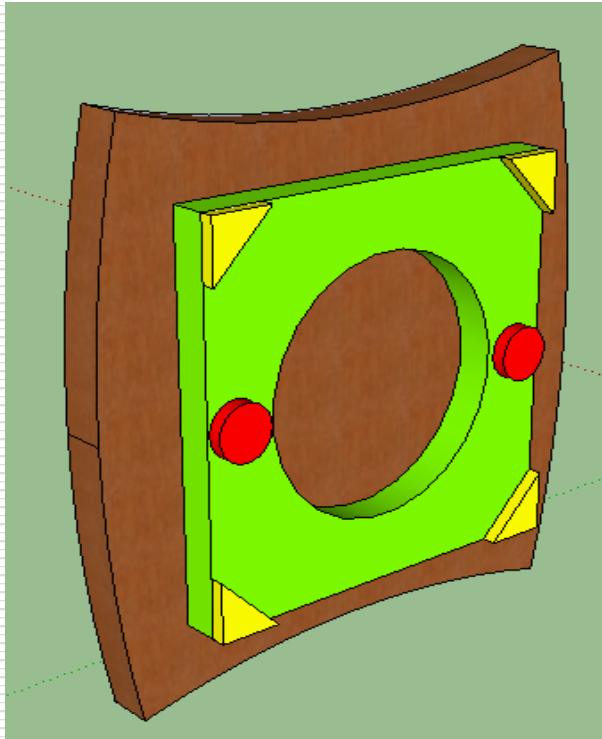

Example 1

Cup Mat Design – Sketch Up Example of P.11

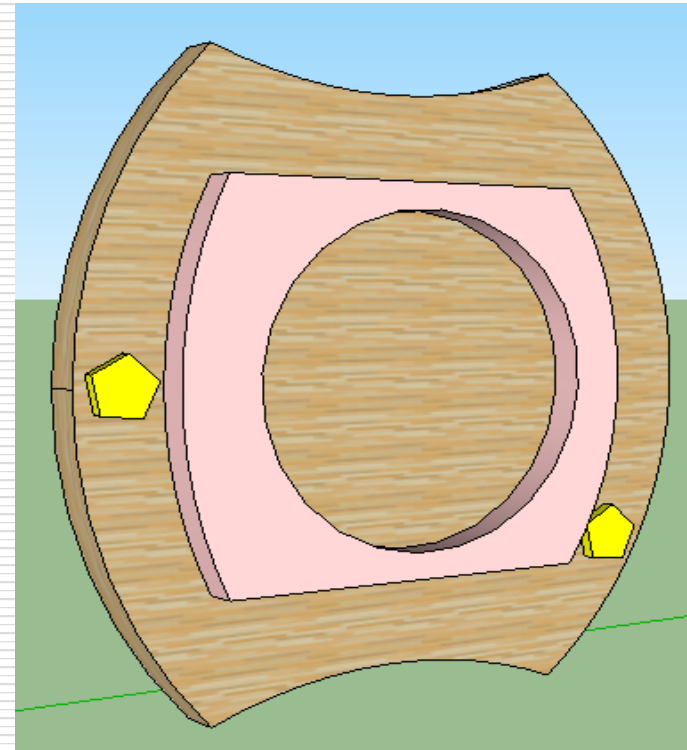
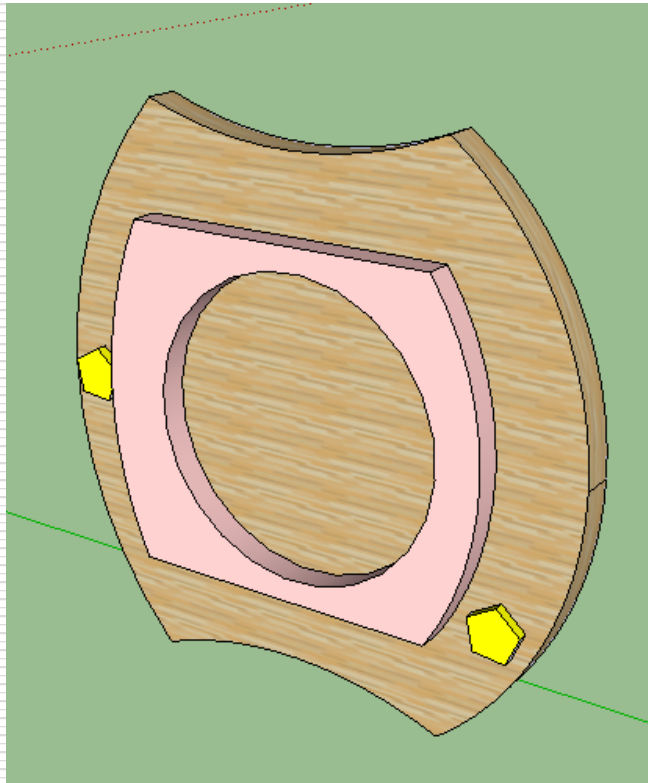

Example 2

Cup Mat Design – Sketch Up Example of P.11

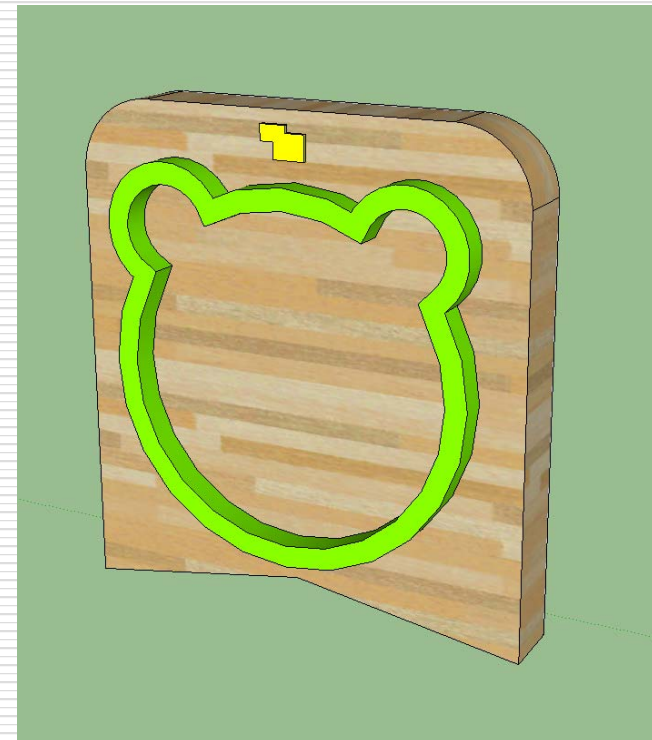
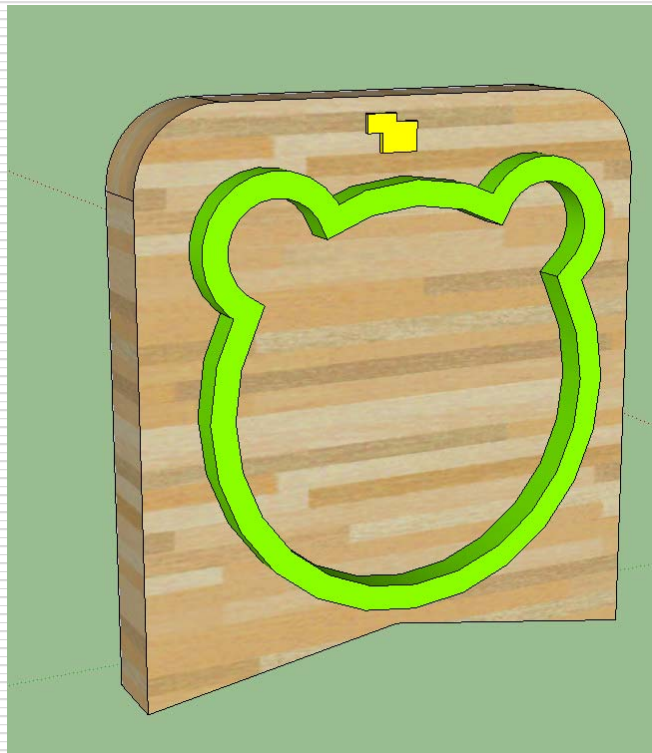

Example 3

Cup Mat Design – Sketch Up Example of P.11

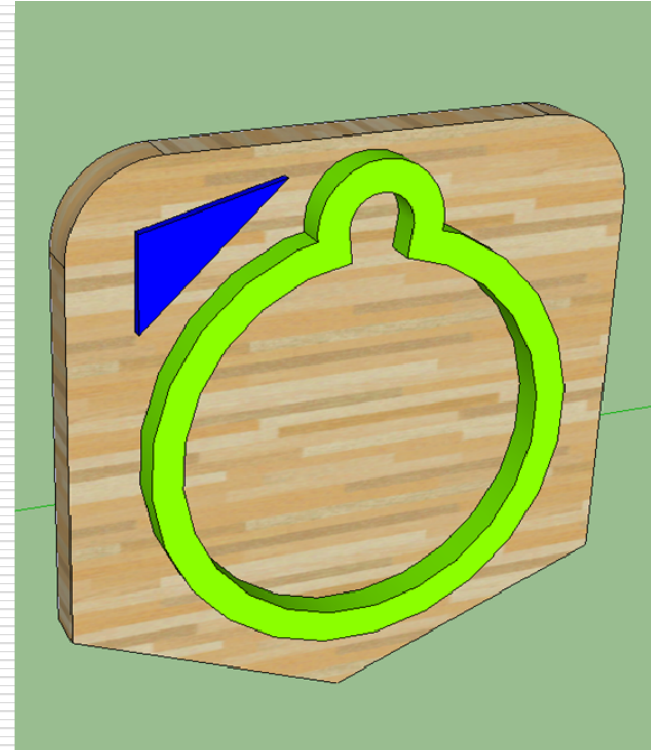
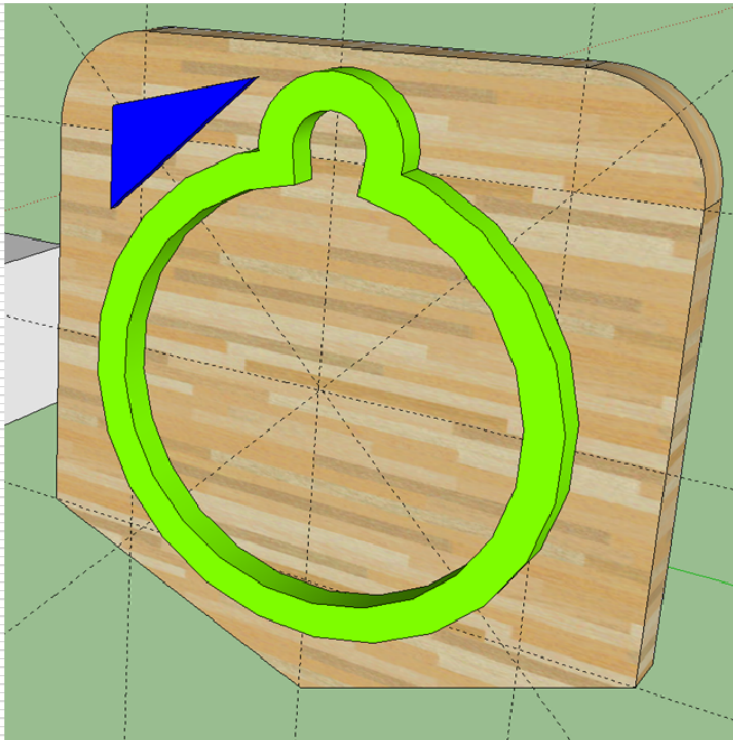

Print Screen



Ctrl C from Sketch Up Web



Ctrl V to Google Slide

Cup Mat Design – Sketch Up Example of P.11

**Graph Paper
(2D)**

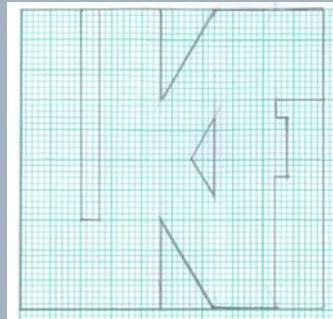

Sketch Up

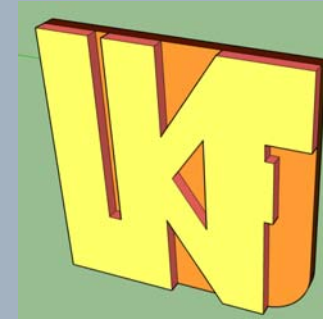
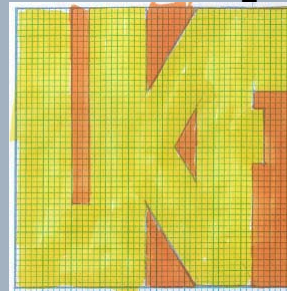

**Graph Paper
(3D)**

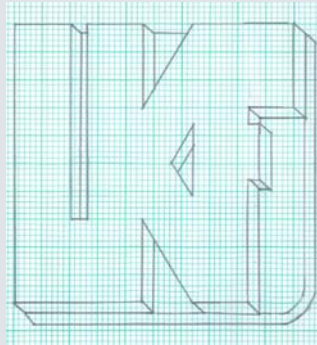

Sketch Up

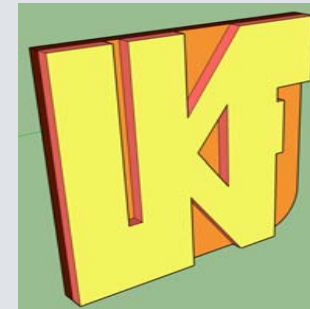
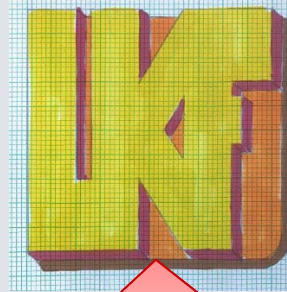

Can not use Sketch Up for School



Design & Technology

2122

F2 Cup Mat

L8-P.18 Zoom

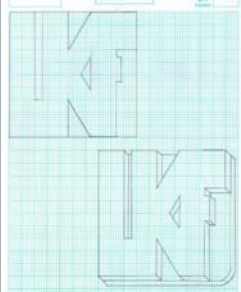
Making – Cup Mat (Example of P.14)

<p>1. Graph Paper Design</p> <p>Description:</p> <ul style="list-style-type: none">-Graph Paper-Pencil-Eraser-Ruler 	<p>2. Sticking with Glue Stick</p> <p>Description:</p> <ul style="list-style-type: none">-Glue Stick-Cutter-Steel Ruler-Paper-Weight 	<p>3. Cutting</p>
<p>4. Coloring</p>	<p>5. Sticking with White Glue</p>	<p>6. Final Product</p>

**1. Description with your own words
by the help of vocabulary provided**

Conclusion:

1. Google Slide

- Insert words & photos**
- Insert print screen image/photo in slide**

2. SketchUp for School / Free Hand Sketching

- Use software to design Cup Mat**
- Coloring on Graph Paper**

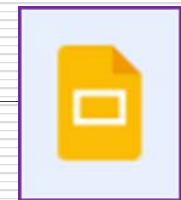

Materials – Prepare for the Next Meeting

1) A 4 繪圖工程網格紙 一張 (CBS)

淘寶 | 中國
Taobao | 香港

情侶裝秋裝外套 搜索

半身裙 保暖襯衫 真皮女包單肩包 書包男 地毯 電動車 短靴 套裝襪秋 春秋外套女修身 更多...

首頁 > 文具電教/文化用品/商務用品 > 更多畫具/書法用品 > 繪圖/白圖紙

加厚座標紙A0網格紙A3學生繪圖建築設計16K8K4K米格a2畫圖手繪製圖a1網格紙a4紅色格子二號圖紙K...

銷量 200+ | 評價 2000+

¥8.80 ¥9.00
約HKD 10.81-20.64

物流 香港地區直郵預計5~8天到達
下單頁多種物流方式可供選擇

支付 AlipayHK Credit/Debit card VISA 支持港幣支付

多規格可選
包郵 坐标纸网格纸

查看詳情並購買 分享

網址: <https://world.taobao.com/item/27142292922.htm?spm=a21wu.10013406-tw.taglist-content.1.4a463887Mv9rL9>

1. Graph Paper (Design)

2. Craft Foam (Top) 彩麗皮

3. Poster board 顏色咭紙

4. Paper (Middle)

5. Glue Stick 漿糊筆

6. Cutter 美工刀

7. 5 Marker 顏色麥克筆5枝

8. White Glue 白膠漿

Learning Tasks :

Google Slide

- **Finished P.12,14**

Making of Cup Mat

- **Cutting of Paper Craft Foam**
- **Cutting of Poster Board**

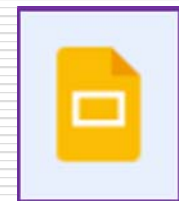

Making – Cup Mat (Example of P.14)

1. Graph Paper Design

Description:

- Graph Paper
- Pencil
- Eraser
- Ruler

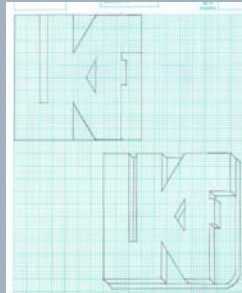

2. Sticking with Glue Stick

Description:.

- Glue Stick
- Cutter
- Steel Ruler
- Paper
- Weight



3. Cutting

Description:.

- Cutter
- Steel Ruler

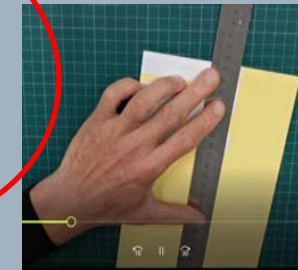

4. Coloring

Description:.

- Marker



5. Sticking with White Glue

6. Final Product

**1. Description with your own words
by the help of vocabulary provided**

Conclusion:

1. Google Slide

- **Insert words & photos**
- **Insert print screen image/photo in slide**

2. Workshop Practice

- **Cutting Craft Foam by Cutter**
- **Cutting Poster Board by Cutter**
- **Cutting Paper by Cutter**

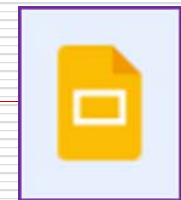

Learning Tasks :

Google Slide

- Update

P.2, P.12,

- Finished

P.13 Making, P.14 Testing, P.15 Evaluation, P.16 STEM

Making of Cup Mat

- Sticking of Cup Mat

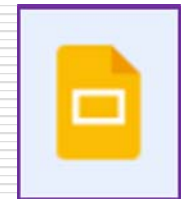

Making – Cup Mat (Example of P.13)

1. Graph Paper Design

Description:

- Graph Paper
- Pencil
- Eraser
- Ruler

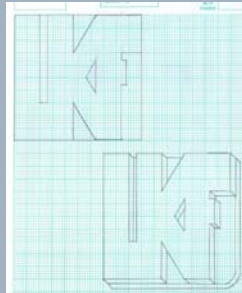

2. Sticking with Glue Stick

Description:.

- Glue Stick
- Cutter
- Steel Ruler
- Paper
- Weight



3. Cutting

Description:.

- Cutter
- Steel Ruler

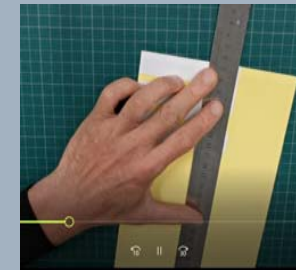

4. Coloring

Description:.

- Marker



5. Sticking with White Glue

Description:.

- White Glue



6. Final Product.

Description:.



1. Description with your own words
by the help of vocabulary provided

Testing (Example of P.14)

- Attractive profile? 吸引的外形?
- Structural stability? 結構穩固?
- Size of cup mat is suitable? 合適大小?
- Appropriate testing location? 合適的測試位置? (第一層)
- Appropriate color configuration? 合適的顏色配置?
- Any improvement? 有何改善?

Essay form and not less than 50 words

- Description with your own words
by the help of the questions provided**
- Insert 3 photos**

Cup Mat & Cup



Separate

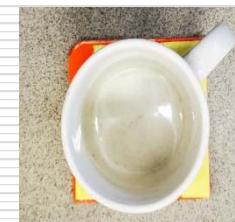

Top View



On Top

Design & Technology

2122

F2 Power Point

L10-P.8 FF

Evaluation (Example of P.15)

Provide 2 or more knowledge you have learned 提供2項或以上你所學到的知識

The most difficult part 最困難部份

Most interesting part 感興趣部份

The easy part 最易掌握部份

Provide 2 points you need to improve 提供2個需改善的地方

Offers 2 points of success 提供2個最感成功地方

Who gave you the most help 誰給予你最大幫助

What you have learnt from tools & material? 工具及材料頁上學到些甚麼?

Is data collection useful? 資料蒐集有幫助否?

Time control is good? 時間管理做得好嗎?

Essay form and not less than 150 words

It is an essay about the whole year DT lesson. What you have learnt, interesting parts, difficult parts, what you can improve, suggestion of the curriculum..... in not less than 150 words.

Design & Technology

F2 Power Point

2122

L10-P.9 FF

STEM (Example of P.16)

Example of Clock Face Design



STEM



聲音感測器
Sound Sensor



光線感測器
Light Sensor



It can put the sound sensor , light sensor and WIFI in the clock face design. This is because we can use sound sensor to play the music or we can use sound sensor to make this design be a clock. When it is 6 o'clock in the morning. It can play a music to make me awake. And we can use the light sensor to make the clock face design more colourful. WIFI can make the clock time more correctly

- We can put the sound sensor to the cup mat too. We can put the sound sensor to the place for put the cup. When we put the cup in there. And it will have a music to play. We also can use the light sensor too. When the cup leave the cup mat. The cup mat will have a red light. When it put into cup mat. It will have a green light.



Print screen

1. Application of sensor(s) **Clock Face Design & Cup Mat**
2. Essay form not less than 50 words for each